

ARABESQUE

by Adriana Lohmann

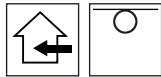

USE



LED



FEATURES

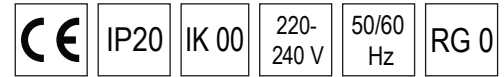

DESCRIPTION

Linear ceiling lamp for interior installations with diffused light. Ideal in environments where sinuous, ethereal, floating and elegant shapes are required. Structure in bent metal, laser-cut and painted. Cover in chromed or golden metal with galvanic finish. Translucent terylene decorative elements in mother-of-pearl white, chrome, gold or copper. The elements are adorned with precious crystal gems. The choice of colors, finishes and lengths of the elements is customizable. Equipped with Led circuits with high color rendering index (CRI90) and high-energy efficiency. Laser-cut metal dissipating plate. Built-in electronic ballast. All electronic ballasts are equipped with thermal and short-circuit protection, against overloading and overvoltage.

SETTLEMENT CODE

Complete the code by entering the number corresponding to the desired color in the space provided

STRUCTURE COLORS

 Chrome finish: **0**

 Gold finish: **2**

other colors on request

ELEMENTS COLORS

 Gold: **2**

 Chrome: **0**

 Mother pearl: **1**

 Copper: **3**

ARABESQUE SL800

IP20

TYPE

POWER

FLUX¹

LED

27W

3240lm

CODE

CCT 3000°K
CRI > 90

C001 .W

structure elements

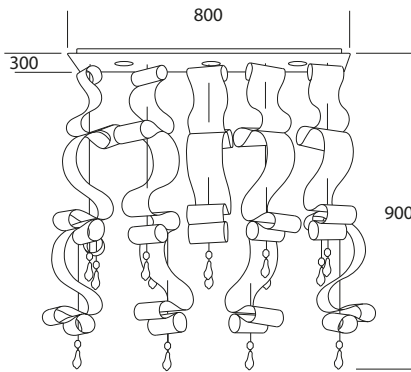

Brightest LED versions on request

ARABESQUE

by Adriana Lohmann



USE

LED

FEATURES

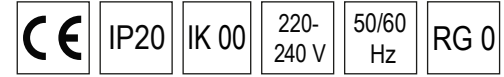
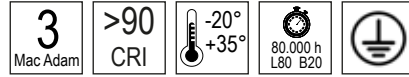
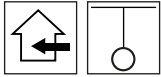

DESCRIPTION

Round ceiling lamp for diffused light indoor installations. Ideal in environments where sinuous, ethereal, floating and elegant shapes are required. Structure in pressed, laser-cut and painted metal. Cover in chromed or golden metal with galvanic finish. Translucent terylene decorative elements in mother-of-pearl white, chrome, gold or copper. The elements are adorned with precious crystal gems. The choice of colors, finishes and lengths of the elements is customizable. Equipped with Led circuits with high color rendering index (CRI90) and high-energy efficiency. Laser-cut metal dissipating plate. Built-in electronic ballast. All electronic ballasts are equipped with thermal and short-circuit protection, against overloading and overvoltage.

SETTLEMENT CODE

Complete the code by entering the number corresponding to the desired color in the space provided

STRUCTURE COLORS

 Chrome finish: **0**

 Gold finish: **2**

other colors on request

ELEMENTS COLORS

 Gold: **2**

 Chrome: **0**

 Mother pearl: **1**

 Copper: **3**

ARABESQUE R300

IP20

TYPE

POWER

FLUX¹

LED

12W

1440lm

CODE

CCT 3000°K
CRI > 90

C002 .W

structure elements

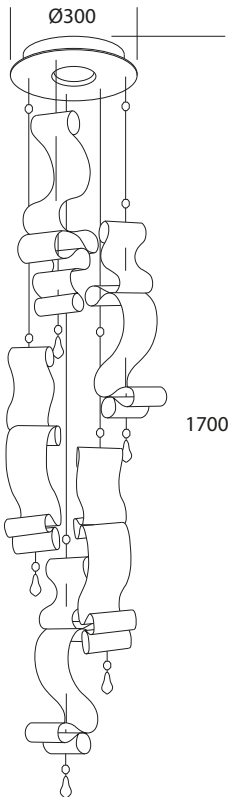

Brightest LED versions on request

ARABESQUE

by Adriana Lohmann



USE

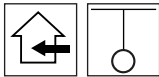

LED



FEATURES

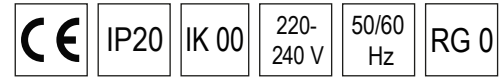

DESCRIPTION

Round ceiling lamp for diffused light indoor installations. Ideal in environments where sinuous, ethereal, floating and elegant shapes are required. Structure in pressed, laser-cut and painted metal. Cover in chromed or golden metal with galvanic finish. Translucent terylene decorative elements in mother-of-pearl white, chrome, gold or copper. The elements are adorned with precious crystal gems. The choice of colors, finishes and lengths of the elements is customizable. Equipped with Led circuits with high color rendering index (CRI90) and high-energy efficiency. Laser-cut metal dissipating plate. Built-in electronic ballast. All electronic ballasts are equipped with thermal and short-circuit protection, protection against overvoltage and overloading.

SETTLEMENT CODE

Complete the code by entering the number corresponding to the desired color in the space provided

STRUCTURE COLORS

 Chrome finish: **0**

 Gold finish: **2**

other colors on request

ELEMENTS COLORS

 Gold: **2**

 Chrome: **0**

 Mother pearl: **1**

 Copper: **3**

ARABESQUE R500

IP20

TYPE

POWER

FLUX¹

LED

36W

4320lm

CODE

CCT 3000°K
CRI > 90

C003 .W

structure elements

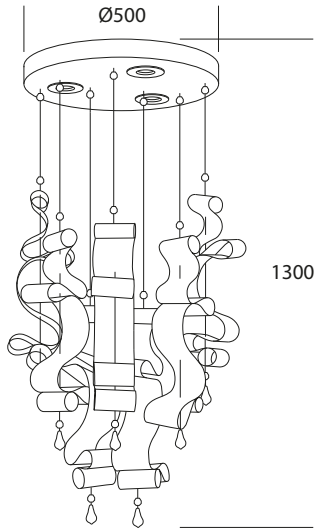

Brightest LED versions on request